

200412301 권용휘
200412359 최원석
200511337 양지승
200611517 정훈섭

Sweet heart

The ultimate coffee machine you've dreamed of (2nd cycle)

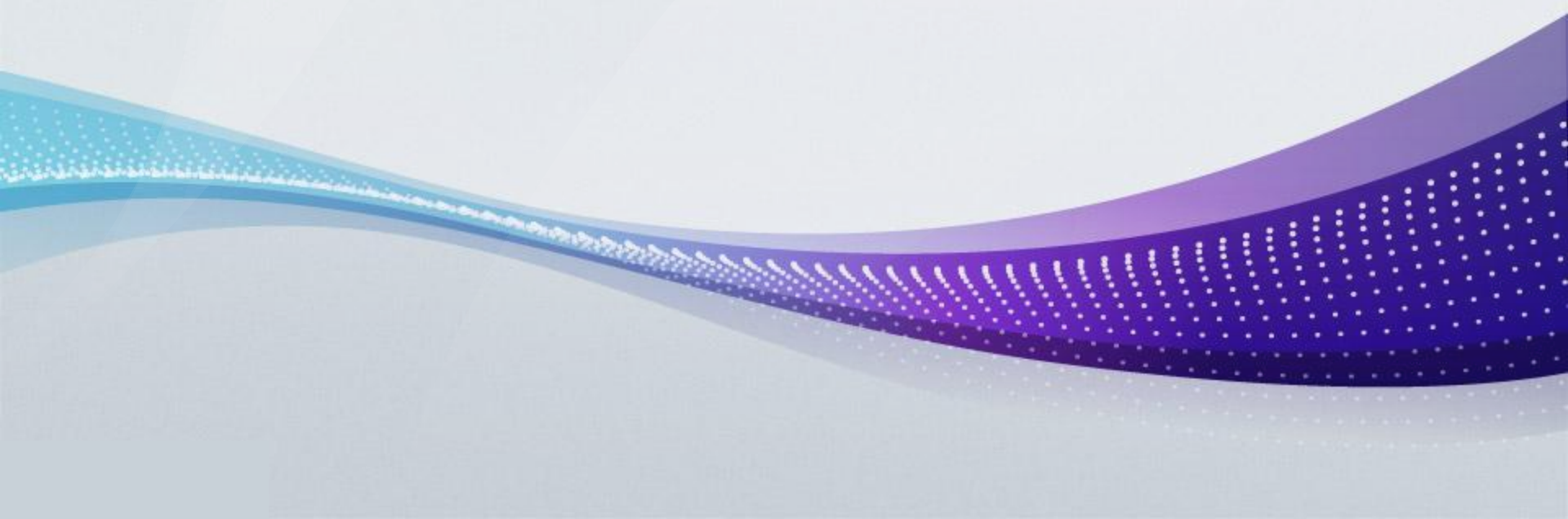

1206. Define Business Use-cases

- Define System boundary

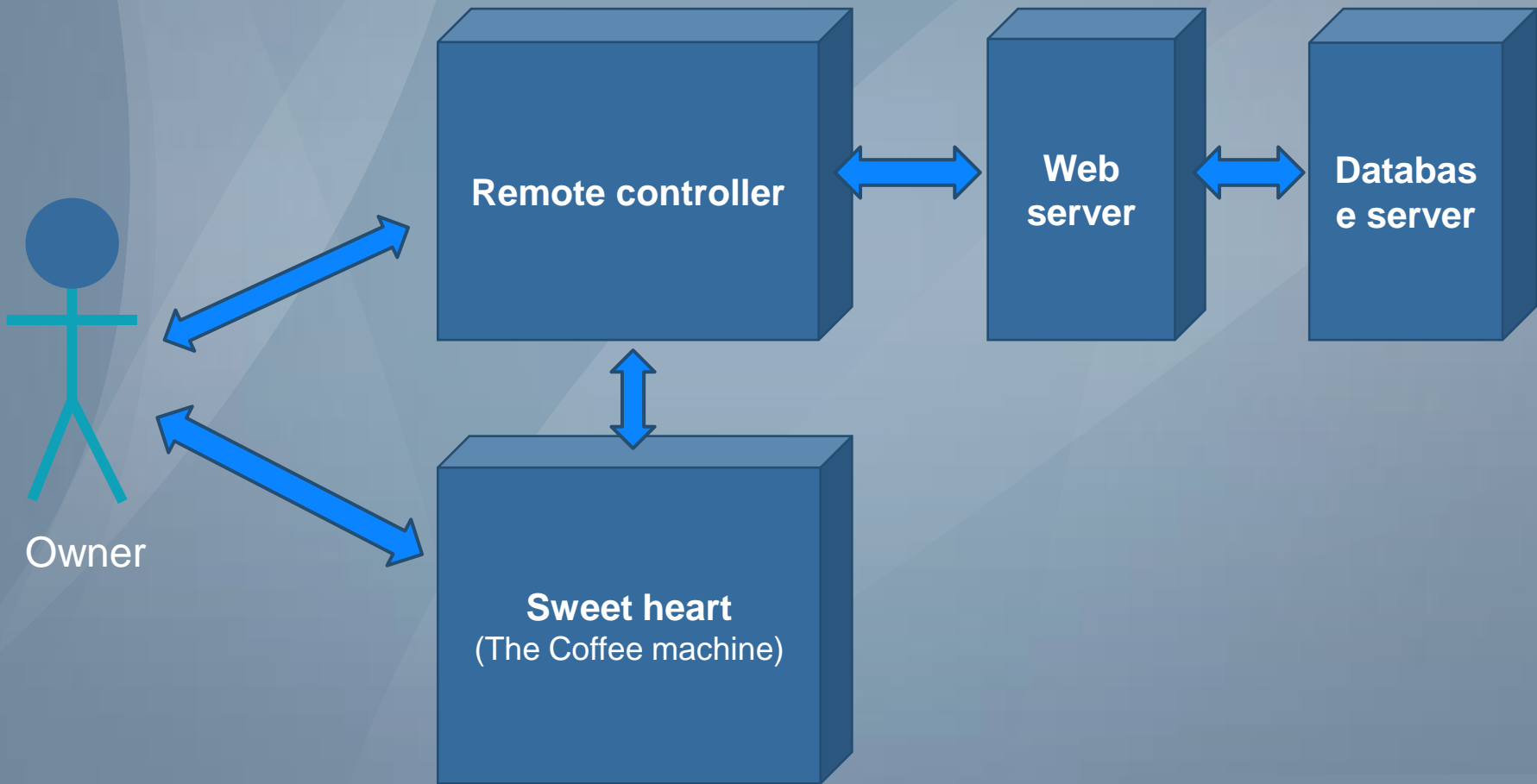

1206. Define Business Use-cases

☰ Categorized use cases (1/2)

Ref. #	Function	Use-case Number and Name	Category
R1.1.1	Register a coffee machine	1. Register a coffee machine	Primary
R1.1.2	Register a remote controller	2. Register a remote controller	Primary
R1.1.3	Request a machine identification number	3. Request a machine identification number	Primary
R1.2.1	Change Mode	4. Change Mode	Primary
R1.2.2	Save personal information	5. Save personal information	Primary
R1.2.3	Update personal information	6. Update personal information	Primary
R1.2.4	Reset saved records	7. Reset saved records	Primary
R1.3.1	Order a cup of coffee	8. Order a cup of coffee	Primary
R1.3.2	Make ordered coffee	9. Make ordered coffee	Primary
R1.3.3	Notify progress	10. Notify progress	Primary
R1.3.4	Cancel ordered coffee	11. Cancel ordered coffee	Primary
R1.4.1	Select music	12. Select music	Primary
R1.4.2	Stop music	13. Stop music	Primary
R1.4.3	Change volume	14. Change volume	Primary

1208. Define Draft System Architecture

Identify 'Concepts' in Domain

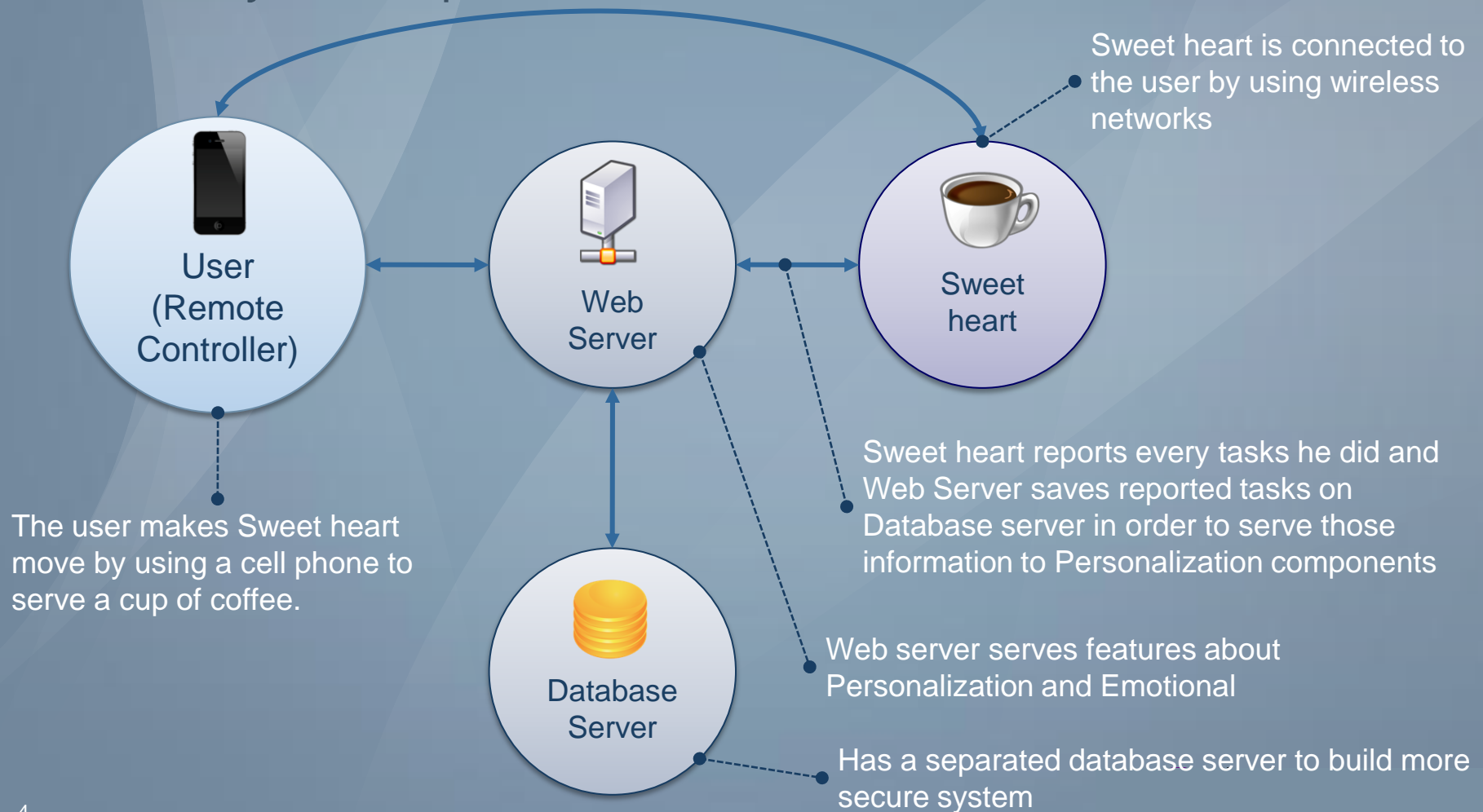

State 2200. Build

Sweet heart

The ultimate coffee machine you've dreamed of

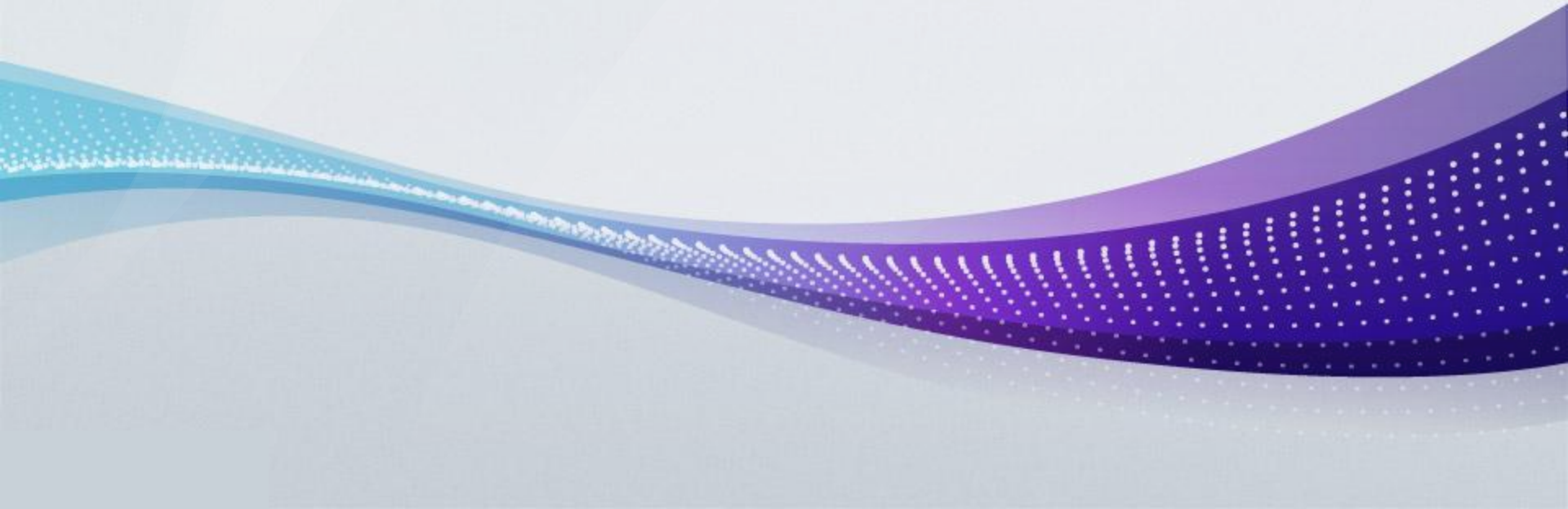

2231. Define Essential Use Cases

1. Register coffee machine

Element	Description
Use case	Register coffee machine
Actor	None
Purpose	Build a list of coffee machines on the web server
Overview	Register identification information of product and remote controller on the web server to authorize the users when they try to access the machine.
Type	Primary and Essential
Cross reference	N/A
Pre-requisites	The sweet heart should be turned on before
Typical courses of events	(A) Actor, (S) System 1. (S) A sweet heart checks whether the coffee machine is registered or not automatically when it is turned on 2. (S) If it is not registered, a sweet heart sends a request to register itself on the web server 3. (S) The web server registers the coffee machine on the database server.
Alternative courses of events	N/A
Exceptional courses of events	N/A

2231. Define Essential Use Cases

2. Register a remote controller

Element	Description
Use case	Register a remote controller
Actor	Owner
Purpose	Build a list of remote controllers and make relationships between sweet heart machines and remote controllers
Overview	Register controller with related coffee machine's information on the web server to authorize the users.
Type	Primary and Essential
Cross reference	Functions : R1.1.3 Use Cases : "Request a machine identification number "
Pre-requisites	The remote controller should be turned on before
Typical courses of events	<ol style="list-style-type: none">1. Actor, (S) System2. (S) A remote controller checks whether it is registered on the web server or not3. (S) If it is not registered, it shows a page to the user to get related sweet heart's identification number4. (A) An actor presses "send button" to send a request to register5. (S) The web server registers the sweet heart on the database server
Alternative courses of events	N/A
Exceptional courses of events	N/A

2231. Define Essential Use Cases

3. Request a machine identification number

Element	Description
Use case	Request a machine identification number
Actor	None
Purpose	Make a relationship between a remote controller and sweet heart
Overview	Receive machine identification number from sweet heart to register a relationship between sweet heart and remote controllers on the web server.
Type	Primary and Essential
Cross reference	Functions : R1.1.1, R1.1.2 Use Cases : "Register a coffee machine", "Register a remote controller"
Pre-requisites	The remote controller should be turned on before. During the execution of "Register a remote controller" use-case, this use-case is invoked by one of the processes of "Register a remote controller" use-case.
Typical courses of events	(A) Actor, (S) System 1. (S) Sweet hearts Request a machine identification number 2. (S) A remote controller receives the identification number from the sweet heart. 3. (S) A remote controller shows received identification number on the screen.
Alternative courses of events	N/A
Exceptional courses of events	N/A

2231. Define Essential Use Cases

4. Change Mode

Element	Description
Use case	Change Mode
Actor	Owner
Purpose	The user selects the mode to be changed
Overview	By using the remote controller to order coffee or listening to music, you can select the mode
Type	Primary and Essential
Cross reference	Functions : R1.1.4 Use Cases : "Change Mode"
Pre-requisites	N/A
Typical courses of events	<ol style="list-style-type: none">1. Actor, (S) System1. (A) An actor selects mode on remote controller.2. (S) The web server checks the selected mode whether it is coffee mode or music mode.3. (S) Depending on the selected mode will work the sweet heart.
Alternative courses of events	N/A
Exceptional courses of events	N/A

2231. Define Essential Use Cases

5. Save personal information

Element	Description
Use case	Save personal information
Actor	Owner
Purpose	Save information for making a recommendation on coffee
Overview	Save personal information including his or her preferences such as preferred coffee beans, sugar portion in the coffee on the web server.
Type	Primary and Essential
Cross reference	Functions : R.1.2.1 R.1.2.3 R.1.2.4 Use Cases : "Change Mode", "Update personal information", "Reset saved records"
Pre-requisites	The controller should be registered on the web server before.
Typical courses of events	(A) Actor, (S) System 1. (A) An actor inputs personal information on the remote controller 2. (S) A remote controller sends information to the web server 3. (S) The web server saves the information 4. (S) The web server sends the result
Alternative courses of events	N/A
Exceptional courses of events	N/A

2231. Define Essential Use Cases

6. Update personal information

Element	Description
Use case	Update personal information
Actor	Owner
Purpose	Update information for making a recommendation on coffee
Overview	Update personal information including his or her information
Type	Primary and Essential
Cross reference	Functions : R.1.2.1 R.1.2.2 R.1.2.4 Use Cases : "Change Mode", "Save personal information", "Reset saved records"
Pre-requisites	The controller should be registered on the web server before.
Typical courses of events	(A) Actor, (S) System 1. (A) An actor inputs personal information on the remote controller 2. (S) A remote controller sends information to the web server 3. (S) The web server updates the information 4. (S) The web server sends the result
Alternative courses of events	N/A
Exceptional courses of events	N/A

2231. Define Essential Use Cases

7. Reset saved records

Element	Description
Use case	Reset saved records
Actor	Owner
Purpose	Initialize learning system by deleting all previously saved user's decisions
Overview	Delete all and initialize the saved user's past decision on the database.
Type	Primary and Essential
Cross reference	Functions : R.1.2.1 R.1.2.2 R.1.2.3 Use Cases : "Change Mode", "Save personal information", "Update personal information"
Pre-requisites	The controller should be registered on the web server before.
Typical courses of events	(A) Actor, (S) System 1. (A) An actor presses "Reset saved records" button on the remote controller 2. (S) A remote controller sends a request to reset all saved records to the web server 3. (S) The web server deletes all saved records 4. (S) The web server sends the result
Alternative courses of events	N/A
Exceptional courses of events	N/A

2231. Define Essential Use Cases

8. Order a cup of coffee

Element	Description
Use case	Order a cup of coffee
Actor	Owner
Purpose	Order a cup of coffee regarding users' taste
Overview	Give an user to various options such as amount of water and size
Type	Primary and Essential
Cross reference	Functions : R.1.3.2, R.1.3.3, R.1.3.4 Use Cases : "Make ordered coffee", "Notify progress", "Cancel ordered coffee"
Pre-requisites	All registration processes should be done and the current mode on the remote controller should be changed to "Coffee Ordering Mode" before.
Typical courses of events	<ol style="list-style-type: none">1. Actor, (S) System2. (A) An actor chooses options about amount of water and size3. (A) An actor presses "Order" button on user interface4. (S) The system checks ingredients on the sweet heart
Alternative courses of events	N/A
Exceptional courses of events	N/A

2231. Define Essential Use Cases

9. Make ordered coffee

Element	Description
Use case	Make ordered coffee
Actor	Owner
Purpose	Sends commands to the sweet heard in order to make a cup of coffee
Overview	This use cases includes lots of trivial operations on the machine in order to make a cup of coffee. During making a cup of coffee, the sweet heart and the remote controller both send and receive status information asynchronously.
Type	Primary and Essential
Cross reference	Functions : R.1.3.1, R.1.3.3, R.1.3.4 Use Cases : "Order a cup of coffee", "Notify progress", "Cancel ordered coffee"
Pre-requisites	All registration processes should be done and "Order a cup of coffee" use-case should be executed before.
Typical courses of events	(A) Actor (S) System 1. (A) An actor presses "order" button on the remote controller 2. (S) The web server saves user decision 3. (S) The sweet heart makes a cup of coffee
Alternative courses of events	N/A
Exceptional courses of events	N/A

2231. Define Essential Use Cases

10. Notify progress

Element	Description
Use case	Notify progress
Actor	None
Purpose	Notify the progress during making a cup of coffee
Overview	Send notification messages to the remote controller to show information of progress to the user
Type	Primary and Essential
Cross reference	Functions : R.1.3.1, R.1.3.2, R.1.3.4 Use Cases : "Order a cup of coffee", "Make ordered coffee", "Cancel ordered coffee"
Pre-requisites	All registration processes should be done and "Make ordered coffee" use-case should be executed before.
Typical courses of events	(A) Actor, (S) System 1. (S) The sweet heart checks all machine's status 2. (S) If the coffee machine finished to make a coffee, send a message to the remote controller 3. (S) The remote controller updates its screen according to the received information
Alternative courses of events	N/A
Exceptional courses of events	N/A

2231. Define Essential Use Cases

11. Cancel ordered coffee

Element	Description
Use case	Cancel ordered coffee
Actor	Owner
Purpose	Allow an user to cancel ordered coffee even if it is in process of making.
Overview	Cancel ordered coffee
Type	Primary and Essential
Cross reference	Functions : R.1.3.1, R.1.3.2, R.1.3.3 Use Cases : "Order a cup of coffee", "Make ordered coffee", "Notify progress"
Pre-requisites	This use-case should be issued during the sweet heart is making a cup of coffee
Typical courses of events	(A) Actor, (S) System 1. (A) An actor presses "Cancel" button on a remote controller 2. (S) A remote controller sends a request to the sweet heart to cancel ordered coffee. 3. (S) A remote controller sends a request to the sweet heart to initializes all machine 4. (S) The sweet heart sends a result message to the remote controller
Alternative courses of events	N/A
Exceptional courses of events	N/A

2231. Define Essential Use Cases

12. Select music

Element	Description
Use case	Select music
Actor	Owner
Purpose	Give options on list of music to users
Overview	Allow an user to select the music in order to play. Lists are shown and aligned by genres and generations.
Type	Primary and Essential
Cross reference	Functions : R1.4.2, R1.4.3 Use Cases : "Stop music", "Change volume"
Pre-requisites	All registration processes should be done and "Make ordered coffee" use-case should be executed before.
Typical courses of events	(A) Actor, (S) System 1. (A) An actor browses the file by selecting files on the screen of a remote controller 2. (S) If music lists are required (not exist), request the music lists to the web server 3. (S) The web server sends music lists to requested remote controller 4. (S) The sweet heart plays received music
Alternative courses of events	N/A
Exceptional courses of events	N/A

2231. Define Essential Use Cases

13. Stop music

Element	Description
Use case	Stop music
Actor	Owner
Purpose	Allow an option to stop the music which is playing now
Overview	Stop the music which is playing now
Type	Primary and Essential
Cross reference	Functions : R1.4.1 R1.4.3 Use Cases : "Select music", "Change volume"
Pre-requisites	The sweet heart should be playing a music when this use-case is issued
Typical courses of events	(A) Actor, (S) System 1. (A) An actor presses "Stop" button on the remote controller 2. (S) A remote controller sends a request to the sweet heart to stop the music 3. (S) The sweet heart stop the music after receiving the stop message from a remote controller
Alternative courses of events	N/A
Exceptional courses of events	N/A

2231. Define Essential Use Cases

14. Change volume

Element	Description
Use case	Change volume
Actor	Owner
Purpose	Allow an option to change volume while it is playing a music
Overview	Change the system volume
Type	Primary and Essential
Cross reference	Functions : R1.4.1 R1.4.2 Use Cases : "Select music", "Stop music"
Pre-requisites	N/A
Typical courses of events	(A) Actor, (S) System 1. (A) An actor adjusts volume by using a remote controller 2. (R) A remote controller sends a request to the sweet heart to adjust volume 3. (S) The sweet heart changes the volume
Alternative courses of events	N/A
Exceptional courses of events	N/A

State 2240. Design

Sweet heart

The ultimate coffee machine you've dreamed of

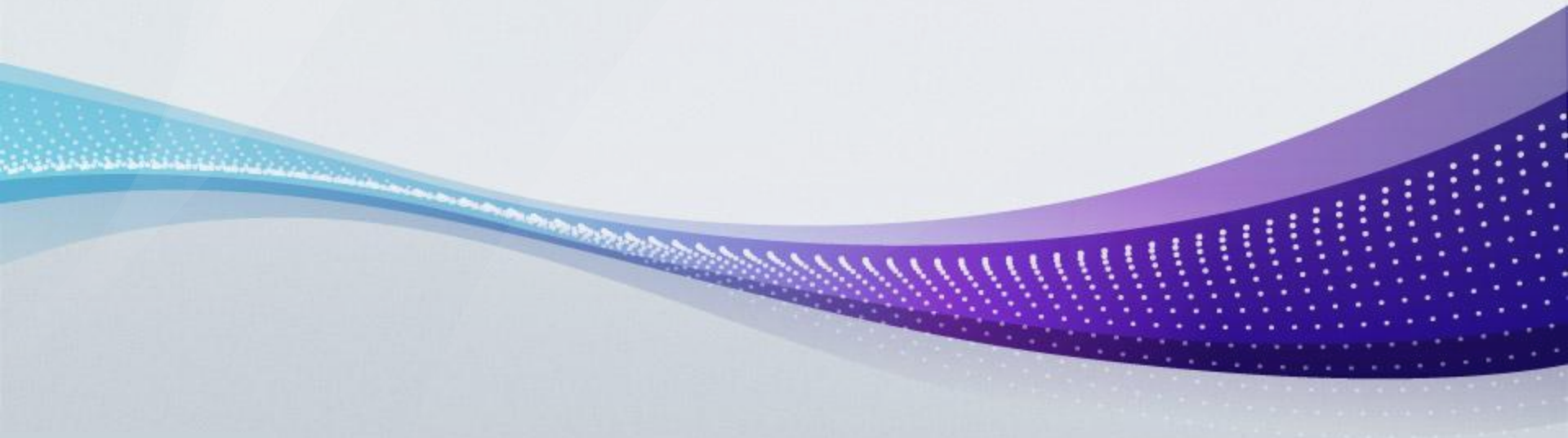

2241. Define Real Use Cases

1. Register a coffee machine

Element	Description
Use case	Register a coffee machine
Actor	None
Purpose	Build a list of coffee machines on the web server
Overview	Register a coffee machine on the server to match and authorize an user and a machine
Type	Primary and Real
Cross reference	Functions : R1.1.2, R1.1.3 Use Cases : Register a remote controller", "Request a machine identification number "
Pre-requisites	The sweet heart should be turned on. (* OnInitSystem() will be invoked when the machine is turned on. This sequence diagram will start from this function.)
Typical courses of events	(A) Actor, (S) System 1,2. (S) The sweet heart interprets and processes the command from the system function which is "OnInitSystem() 3. (S) The sweet heart obtain machine id number 4,5. (S) The sweet heart generates and sends a message to the web server 6,7. (S) The web server interprets and processes the command from the sweet heart 8,9,10. (S) The web server registers the sweet heart if it is not registered on the web server. 11,12. (S) The web server generates and sends a message to the sweet heart to notify the result 13,14. (S) The sweet heart interprets and processes the command from the web server
Alternative courses of events	N/A
Exceptional courses of events	N/A

2241. Define Real Use Cases

2. Register a remote controller

Element	Description
Use case	Register a remote controller
Actor	Owner
Purpose	Build a list of remote controllers and make relationships between sweet heart machines and remote controllers
Overview	Register a remote controller on the server to match and authorize an user and a remote controller
Type	Primary and Real
Cross reference	Functions : R1.1.1, R1.1.3 Use Cases : "Register a coffee machine", "Request a machine identification number "
Pre-requisites	The remote controller should be turned on
Typical courses of events	<ol style="list-style-type: none">1. Actor, (S) System1. (S) A remote controller checks whether it is registered on the web server or not when the remote controller is turned on.2. (S) If it is not registered, it shows a page to the user to get an identification number of related sweet heart .3,4. (S) The remote controller generates and sends a message to request machine identification number to the sweet heart by invoking use case #3.

2241. Define Real Use Cases

2. Register a remote controller (cont')

Element	Description
Typical courses of events	<ol style="list-style-type: none">1. Actor, (S) System5. (S) The sweet heart invokes use case #3 and generates and sends a result message to the remote controller.6,7,8. (S) The remote interprets and processes a result message and shows the identification number on the screen (B).9. (A) An owner confirms to send a request to register by pressing the button(C).10,11. (S) The remote controller generates and sends a message to the web server12,13. (S) The web server interprets and processes the commands from the remote controller.14,15,16. (S) The web server registers the remote controller on the database server if the remote controller is not registered.17,18. (S) The web server generates and sends a message to the sweet heart19,20. (S) The sweet heart interprets and processes a message from the web server21. (S) The sweet heart saves identification information of the remote controller22,23. (S) The sweet heart generates and sends a message to the remote controller24,25. (S) The sweet heart interprets and processes a message from the web server26. (S) The sweet heart updates the result of process and shows it.
Alternative courses of events	N/A
Exceptional courses of events	N/A

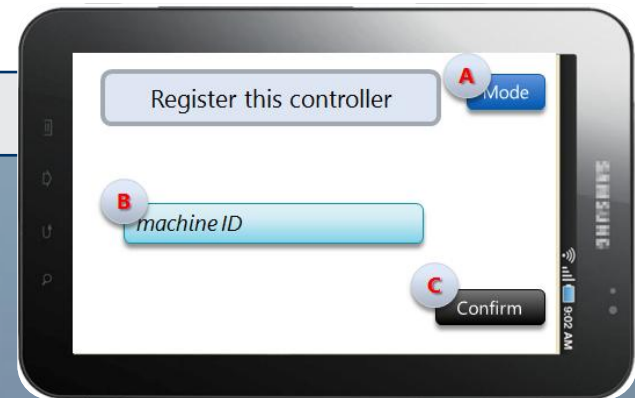

2241. Define Real Use Cases

3. Request a machine identification number

Element	Description
Use case	Request a machine identification number
Actor	None
Purpose	Make a relationship between a remote controller and sweet heart
Overview	Request a machine identification number to a coffee machine in order to match and authorize a remote controller and a coffee machine
Type	Primary and Real
Cross reference	Functions : R1.1.1, R1.1.2 Use Cases : "Register a coffee machine", "Register a remote controller"
Pre-requisites	The remote controller should be turned on before This sequence diagram starts when the sweet heart receives a request message for machine identification number.
Typical courses of events	1. Actor, (S) System 1,2. (S) The sweet heart interprets and processes the command from the remote controller 3. (S) The sweet heart obtain machine id number 4,5. (S) The sweet heart generates and sends a message to the web server
Alternative courses of events	N/A
Exceptional courses of events	N/A

2241. Define Real Use Cases

4. Change Mode

Element	Description
Use case	Change Mode
Actor	Owner
Purpose	Change mode on the remote controller to change options on the system
Overview	Allow users to change modes such as “Coffee Ordering mode”, “Personal Information mode” and “Music Selecting Mode”
Type	Primary and Real
Cross reference	Functions : R1.2.2, R1.2.3, R1.2.4, R1.3.1, R1.4.1 Use Cases : “Save personal information”, “Update personal information”, “Reset saved record”, “Order a cup of coffee”, “Select music”
Pre-requisites	The controller should be registered on the web server before.
Typical courses of events	(A) Actor, (S) System 1. (A) An owner selects a mode on the remote controller (from B to F on the next page’s screen shot) 2,3,4,5,6,7. (S) The remote controller generates and sends a message to the sweet heart and web server according to the mode user has been selected. 8,9. (S) The sweet heart interprets and processes a message from the remote controller. 10,11,12,13. (S) The sweet heart checks the remained ingredients in order to clarify whether or not the machine can make a cup of coffee. 14,15. (S) The sweet heart generates and sends the result message to the remote controller. 16,17. (S) The remote controller interprets and processes a message from the sweet heart. 18,19. (S) The remote controller updates the remained ingredients information on the screen(R on the next page’s screen shot) and saves the information on the remote controller.

2241. Define Real Use Cases

4. Change Mode (cont')

Element	Description
Typical courses of events	(A) Actor, (S) System 20,21. (S) The web server interprets and processes a message from the remote controller. 22,23,24,25. (S) The web server obtains music lists and coffee and music to recommend in order to send it to the remote controller. 26,27. (S) The web server generates and sends the result message to the remote controller 28,29. (S) The remote controller interprets and processes a message from the web server. 30. (S) The remote controller shows the result on the screen.
Alternative courses of events	N/A
Exceptional courses of events	N/A

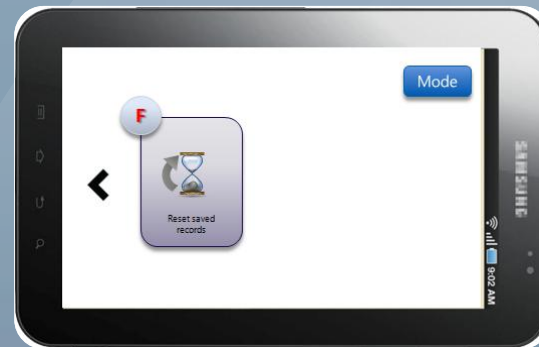

2241. Define Real Use Cases

5. Save personal information

Element	Description
Use case	Save personal information
Actor	Owner
Purpose	Save information for making a recommendation on coffee
Overview	Save personal information including his or her information
Type	Primary and Real
Cross reference	Functions : R.1.2.1 R.1.2.3 R.1.2.4 Use Cases : "Change Mode", "Update personal information", "Reset saved records"
Pre-requisites	The controller should be registered on the web server and the current mode on the remote controller should be changed to "Personal Information Mode" before.
Typical courses of events	(A) Actor, (S) System 1. (A) An owner inputs information(Birth on A, B and C, Favorite Coffee on D on the screen) and presses save button(E on the screen) on the remote controller.

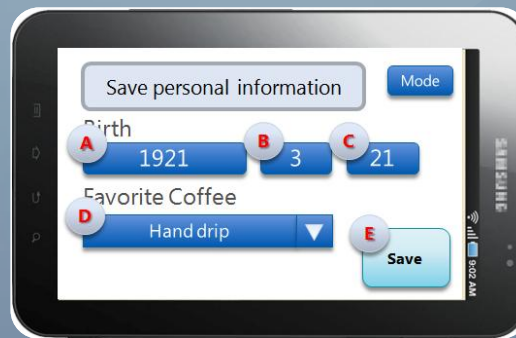

2241. Define Real Use Cases

5. Save personal information (cont')

Element	Description
Typical courses of events	(A) Actor, (S) System 2,3. (S) The remote controller generates and sends a message to the web server. 4,5. (S) The web server interprets and processes a message from the remote controller. 6,7. (S) The web server saves personal information from the remote controller on the database server. 8,9. (S) The web server generates and sends the result message to the remote controller. 10,11. (S) The remote controller interprets and processes a message from the web server. 12. (S) The remote controller shows the result on the screen.
Alternative courses of events	N/A
Exceptional courses of events	N/A

2241. Define Real Use Cases

6. Update personal information

Element	Description
Use case	Update personal information
Actor	Owner
Purpose	Update information for making a recommendation on coffee
Overview	Update personal information including his or her information
Type	Primary and Real
Cross reference	Functions : R.1.2.1 R.1.2.2 R.1.2.4 Use Cases : "Change Mode", "Save personal information", "Reset saved records"
Pre-requisites	The controller should be registered on the web server and the current mode on the remote controller should be changed to "Personal Information Mode" before.
Typical courses of events	(A) Actor, (S) System 1. (A) An owner inputs information(Birth on A, B and C, Favorite Coffee on D on the screen) and presses update button(E on the screen) on the remote controller.



2241. Define Real Use Cases

6. Update personal information (cont')

Element	Description
Typical courses of events	(A) Actor, (S) System 2,3. (S) The remote controller generates and sends a message to the web server. 4,5. (S) The web server interprets and processes a message from the remote controller. 6,7. (S) The web server updates personal information from the remote controller on the database server. 8,9. (S) The web server generates and sends the result message to the remote controller. 10,11. (S) The remote controller interprets and processes a message from the web server. 12. (S) The remote controller shows the result on the screen.
Alternative courses of events	N/A
Exceptional courses of events	N/A

2241. Define Real Use Cases

7. Reset saved records

Element	Description
Use case	Reset saved records
Actor	Owner
Purpose	Initialize learning system by deleting all previously saved user's decisions
Overview	Reset saved records such as ordered coffee history to initialize machine
Type	Primary and Real
Cross reference	Functions : R.1.2.1 R.1.2.2 R.1.2.3 Use Cases : "Change Mode", "Save personal information", "Update personal information"
Pre-requisites	The controller should be registered on the web server and the current mode on the remote controller should be changed to "Option Mode" before.
Typical courses of events	(A) Actor, (S) System 1. (A) An owner pushes the reset button (F on the next page's screen shot) 2,3. (S) The remote controller generates message & sends to the web server 4,5. (S) The web server interprets the command from the remote controller & processes the message according to the command in the message 6. (S) The web server deletes all records on the database server. 7. (S) The web server queries to database and gets information 8,9. (S) The web server generates and sends a message to the remote controller 10,11. (S) The remote controller interprets the command from the remote controller and processes the message according to the command in the message 12. (S) The remote controller updates the current page

2241. Define Real Use Cases

7. Reset saved records (cont')

Element	Description
Alternative courses of events	N/A
Exceptional courses of events	N/A



2241. Define Real Use Cases

8. Order a cup of coffee

Element	Description
Use case	Order a cup of coffee
Actor	Owner
Purpose	Order a cup of coffee regarding users' taste
Overview	Show regular coffee menu with recommended coffee to give an user variety options. Also, this function allows an user to choose size of coffee and portion of water in order to adjust the strength of coffee.
Type	Primary and Real
Cross reference	Functions : R.1.3.2, R.1.3.3, R.1.3.4 Use Cases : "Make ordered coffee", "Notify progress", "Cancel ordered coffee"
Pre-requisites	All registration processes should be done and the current mode on the remote controller should be changed to "Coffee Ordering Mode" before.
Typical courses of events	(A) Actor, (S) System 1. (A) An owner inputs information about coffee. (A, B, D on the screen shot) 2. (A) An owner presses button on the remote controller (C on the screen shot) 3. (S) The remote controller checks remained ingredients 4,5. (S) The remote controller updates the current page
Alternative courses of events	N/A
Exceptional courses of events	N/A



2241. Define Real Use Cases

9. Make ordered coffee

Element	Description
Use case	Make ordered coffee
Actor	Owner
Purpose	Sends commands to the sweet heard in order to make a cup of coffee
Overview	After all ordering processes have been done, this function sends a message to the web server and the coffee machine in order to make a cup of coffee according to the user's order.
Type	Primary and Real
Cross reference	Functions : R.1.3.1, R.1.3.3, R.1.3.4 Use Cases : "Order a cup of coffee", "Notify progress", "Cancel ordered coffee"
Pre-requisites	All registration processes should be done and "Order a cup of coffee" use-case should be executed before.
Typical courses of events	(A) Actor, (S) System 1. (A) An owner presses the make a cup of coffee button (A on the next page's screen shot) on the remote controller 2,3. (S) The remote controller generates and sends a message to the web server 4,5. (S) The web server interprets and processes the command from the remote controller according to the command in the message. 6. (S) The web server saves user's choice on the database if the message is making a cup of coffee. 7. (S) The web server queries to database and gets information 8,9. (S) The web server generates and sends a message to the remote controller 10,11. (S) The remote controller interprets and processes the command from the web server according to the command in the message.

2241. Define Real Use Cases

9. Make ordered coffee (cont')

Element	Description
Typical courses of events	(A) Actor, (S) System 12,13. (S) The remote controller generates and sends message to the sweet heart 14,15. (S) The sweet heart interprets and processes the command from the remote controller the message according to the command in the message. 16. (S) The sweet heart registers the remote controller to notify the progress during the working 17,18,19,20,21,22. (S) The sweet heart orders each extra machines to work them selves 23,24. (S) The sweet heart generates and sends message to the remote controller 25,26. (S) The remote controller interprets and processes the command from the sweet heart according to the command in the message. 27. (S) The remote controller updates the current page
Alternative courses of events	N/A
Exceptional courses of events	N/A



2241. Define Real Use Cases

10. Notify progress

Element	Description
Use case	Notify progress
Actor	None
Purpose	Notify the progress during making a cup of coffee
Overview	During the making ordered coffee function is executing, the coffee machine and the remote controller register a notification event listener to monitor the progress of the work in order to let user know the progress.
Type	Primary and Real
Cross reference	Functions : R.1.3.1, R.1.3.2, R.1.3.4 Use Cases : "Order a cup of coffee", "Make ordered coffee", "Cancel ordered coffee"
Pre-requisites	All registration processes should be done and "Confirm a cup of coffee" use-case should be executed before.
Typical courses of events	(A) Actor, (S) System 1,2,3,4. (S) The sweet heart gets information about making process when the notification message is arrived. 5,6. (S) The sweet heart generates and sends a message to the remote controller 7,8. (S) The remote controller interprets and processes the command from the sweet heart according to the command in the message. 9. (S) The remote controller updates the current page (A part A on the screen shot)
Alternative courses of events	N/A
Exceptional courses of events	N/A

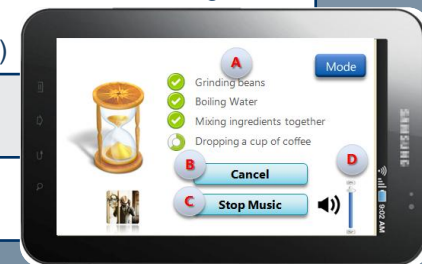

2241. Define Real Use Cases

11. Cancel ordered coffee

Element	Description
Use case	Cancel ordered coffee
Actor	Owner
Purpose	Allow an user to cancel ordered coffee even if it is in process of making.
Overview	Cancel ordered coffee which might be in progress of making. If a machine received a cancel command, it stops producing immediately and give it to the user even if it is not finished.
Type	Primary and Real
Cross reference	Functions : R.1.3.1, R.1.3.2, R.1.3.3 Use Cases : "Order a cup of coffee", "Make ordered coffee", "Notify progress"
Pre-requisites	All registration processes should be done and "Confirm ordered coffee" use-case should be executed before.
Typical courses of events	(A) Actor, (S) System 1. (A) An owner presses the cancel button(B on the next page's screen shot) on the remote controller 2,3. (S) The remote controller generates and sends message to the sweet heart 4,5. (S) The sweet heart interprets and processes the command from the remote controller according to the command in the message. 6,7,8,9,10. (S) The sweet heart aborts work and initializes each machine 11,12. (S) The sweet heart generates and sends message to the remote controller 13,14. (S) The remote controller interprets and processes the command from the sweet heart according to the command in the message. 15. (S) The remote controller updates the current page

2241. Define Real Use Cases

11. Cancel ordered coffee (cont')

Element	Description
Alternative courses of events	N/A
Exceptional courses of events	N/A



2241. Define Real Use Cases

12. Select music

Element	Description
Use case	Select music
Actor	Owner
Purpose	Give options on list of music to users
Overview	Allow to select a music based on a genre or a musician by navigating lists. Also, it includes a play music function in order to serve a comfortable and romantic atmosphere during your coffee break
Type	Primary and Real
Cross reference	Functions : R1.2.1, R1.4.2, R1.4.3 Use Cases : "Change Mode", "Stop music", "Change volume"
Pre-requisites	All registration processes should be done and "Confirm ordered coffee" use-case should be executed before.
Typical courses of events	(A) Actor, (S) System 1. (A) An owner selects a music(A on the next page's screen shot) and presses the play button(B on the next page's screen shot) on the remote controller 2. (S) The remote controller checks whether or not it has up-to-date music lists 3,4. (S) The remote controller generates and sends message to the web server if it has not up-to-date music lists 5,6. (S) The web server interprets and processes the command from the remote controller according to the command in the message 7,8. (S) The web server obtains up-to-date music lists on its storage. 9,10. (S) The web server generates and sends message to the remote controller 11,12. (S) The remote controller interprets and processes the command from the web server according to the command in the message.

2241. Define Real Use Cases

12. Select music (cont')

Element	Description
Typical courses of events	(A) Actor, (S) System 13. (S) The remote controller updates the music lists using the received information. 14. (S) The remote controller updates page 15,16. (S) The remote controller generate message & send to the web server 17,18. (S) The web server interprets and processes the command from the remote controller according to the command in the message 19. (S) The web server obtains binary data of the certain music file to be played. 20,21. (S) The web server generates and sends a message which contains the file contents to the sweet heart 22,23. (S) The sweet heart interprets and processes the command from the web server according to the command in the message. 24. (S) The sweet heart plays music
Alternative courses of events	N/A
Exceptional courses of events	N/A



2241. Define Real Use Cases

13. Stop music

Element	Description
Use case	Stop music
Actor	Owner
Purpose	Allow an option to stop the music which is playing now
Overview	Stop music and move on to the another user interface such as music selection page
Type	Primary and Real
Cross reference	Functions : R1.4.1 R1.4.3 Use Cases : "Select music", "Change volume"
Pre-requisites	All registration processes should be done and "Select music" use-case should be executed before.
Typical courses of events	<ol style="list-style-type: none">1. Actor, (S) System1. (A) An owner presses the stop button(B on the screen shot) on the remote controller2,3. (S) The remote controller generates and sends a message to the sweet heart4,5. (S) The sweet heart interprets and processes the command from the remote controller according to the command in the message.6. (S) The sweet heart stop music7,8. (S) The sweet heart generate and sends message to the remote controller9,10. (S) The remote controller interprets and processes the command from the s command in the message.11. (S) The remote controller updates the current page
Alternative courses of events	N/A
Exceptional courses of events	N/A



2241. Define Real Use Cases

14. Change volume

Element	Description
Use case	Change volume
Actor	Owner
Purpose	Allow an option to change volume while it is playing a music
Overview	Adjust volume to make a good coffee break
Type	Primary and Real
Cross reference	Functions : R1.4.1 R1.4.2 Use Cases : "Select music", "Stop music"
Pre-requisites	All registration processes should be done and "Select music" use-case should be executed before.
Typical courses of events	<ol style="list-style-type: none">1. Actor, (S) System1. (A) An owner changes the current volume(D on the screen shot) on the remote controller2,3. (S) The remote controller generate message & send to the sweet heart4. (S) The remote controller updates the current page5,6. (S) The sweet heart interprets and processes the command from the remote controller according to the command in the message.7. (S) The sweet heart changes the current volume
Alternative courses of events	N/A
Exceptional courses of events	N/A

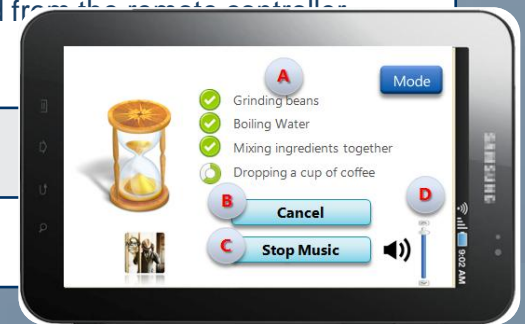

2243. Refine System Architecture

1. Drawing Deployment Diagram



2243. Refine System Architecture

2. Drawing Package Diagram

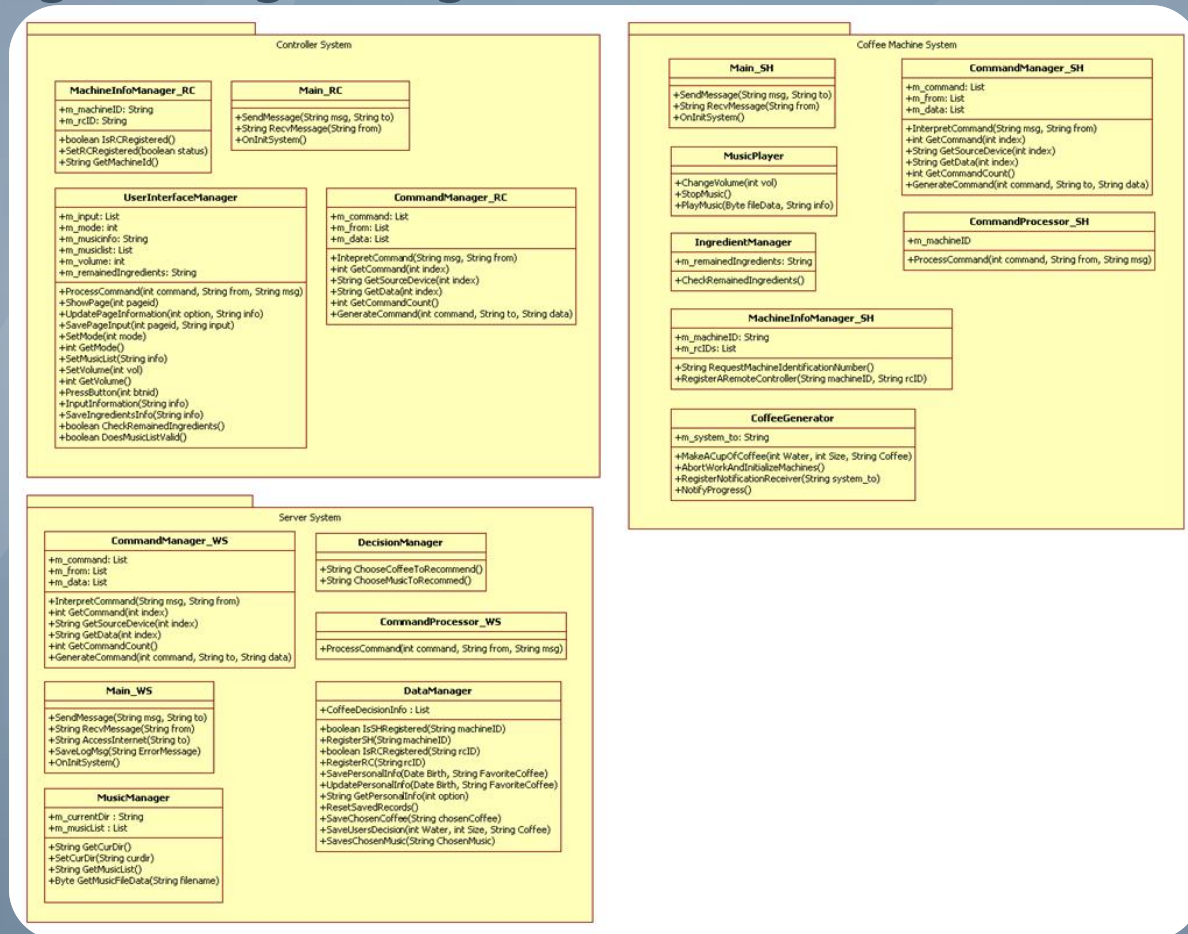

2244. Define Interaction Diagram

3. Request a machine identification number

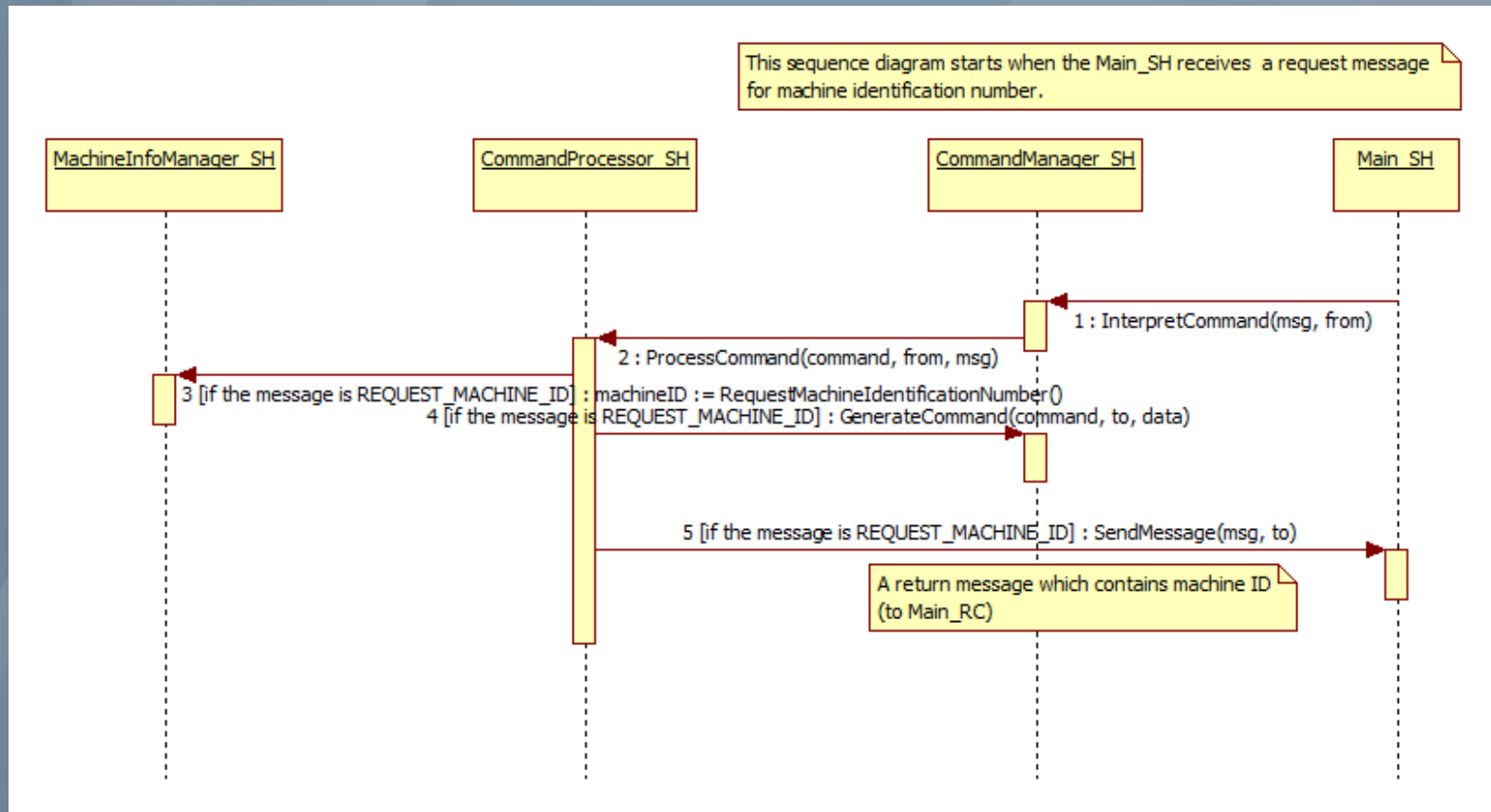

2244. Define Interaction Diagram

5. Save personal information

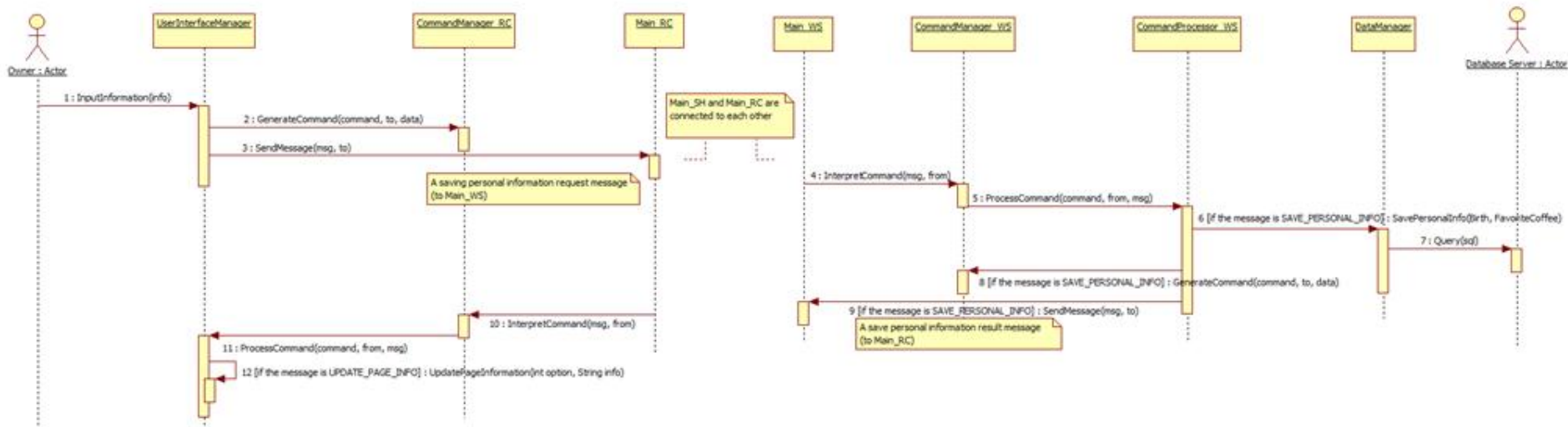

2244. Define Interaction Diagram

6. Update personal information

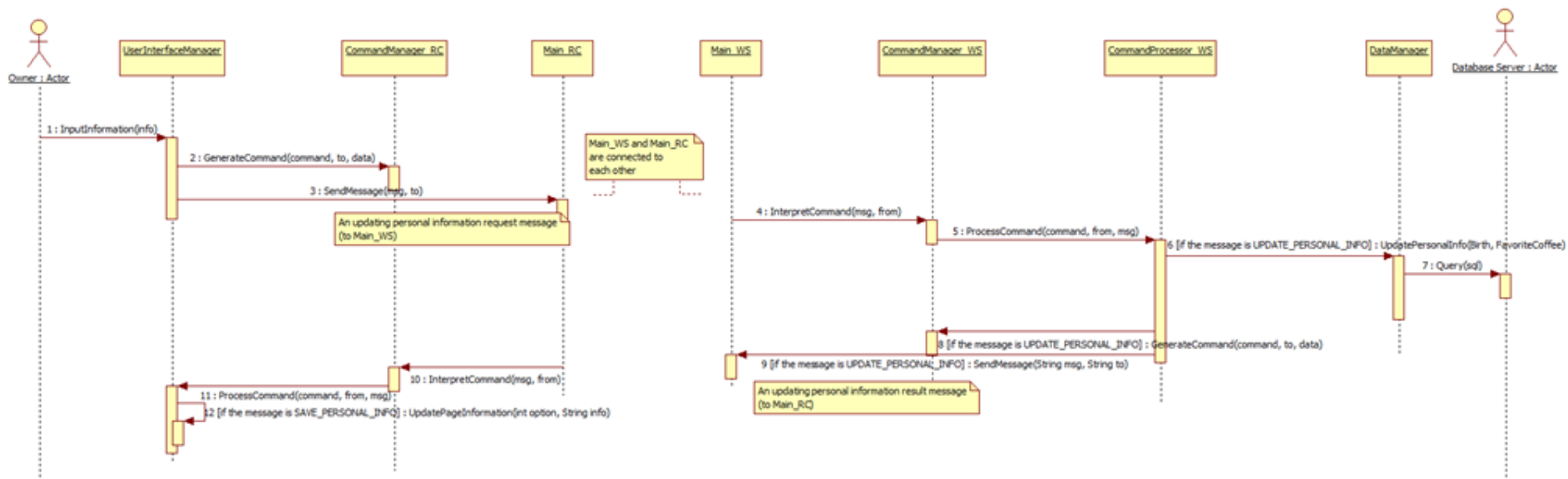

2244. Define Interaction Diagram

7. Reset saved records

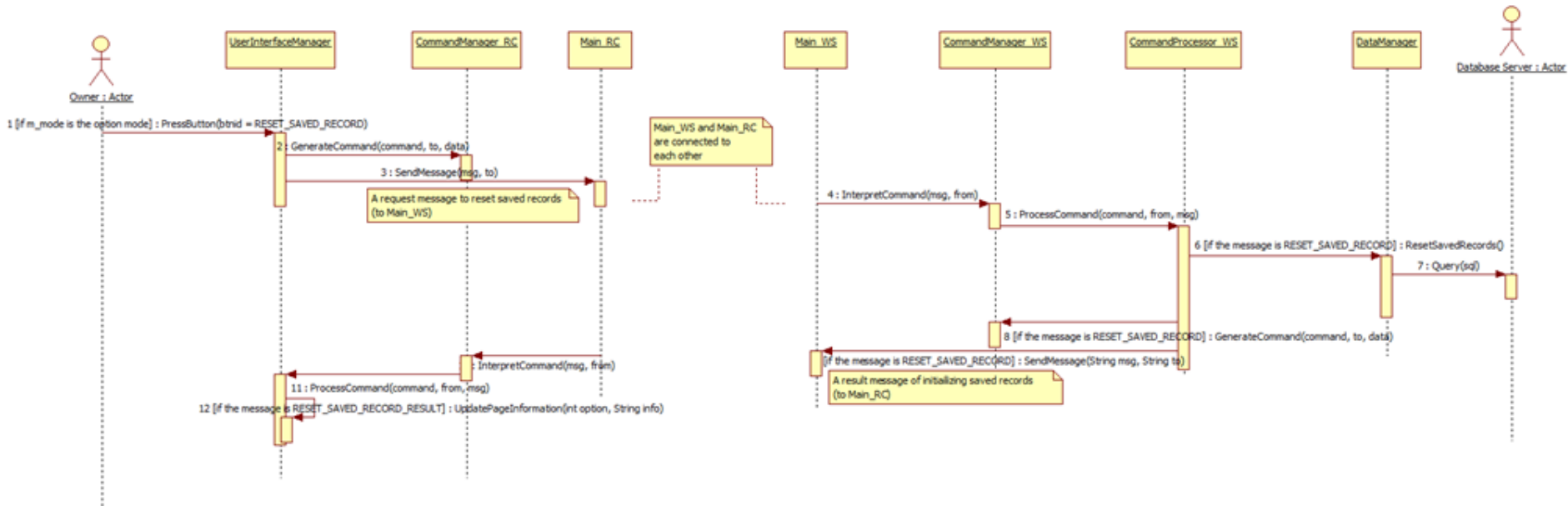

2244. Define Interaction Diagram

8. Order a cup of coffee

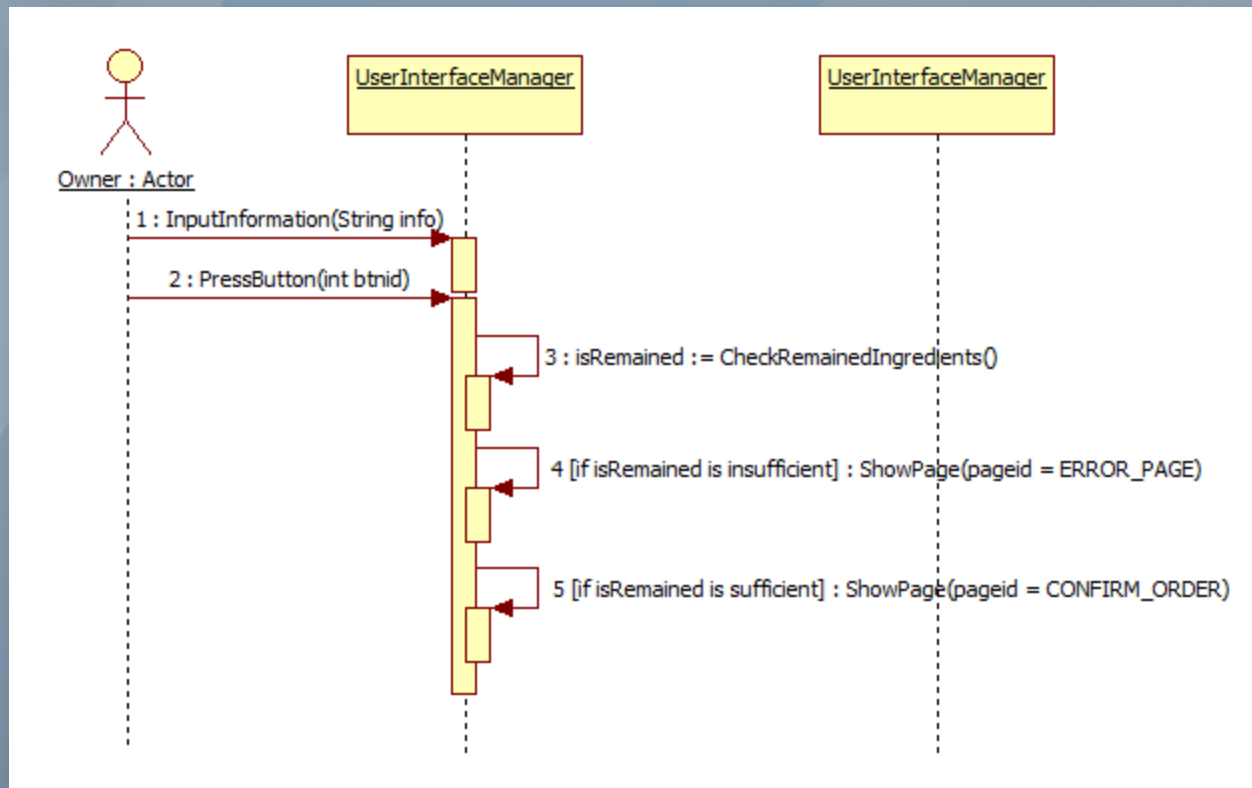

2244. Define Interaction Diagram

9. Make ordered coffee

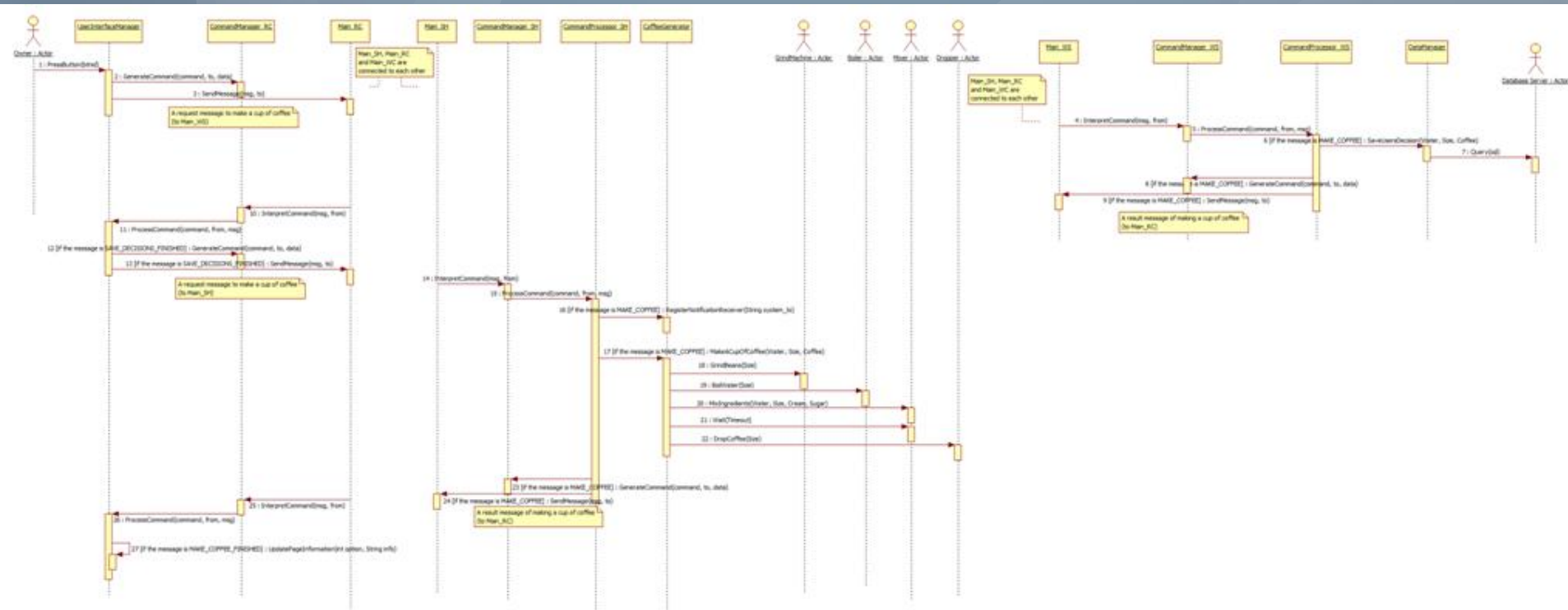

2244. Define Interaction Diagram

10. Notify progress

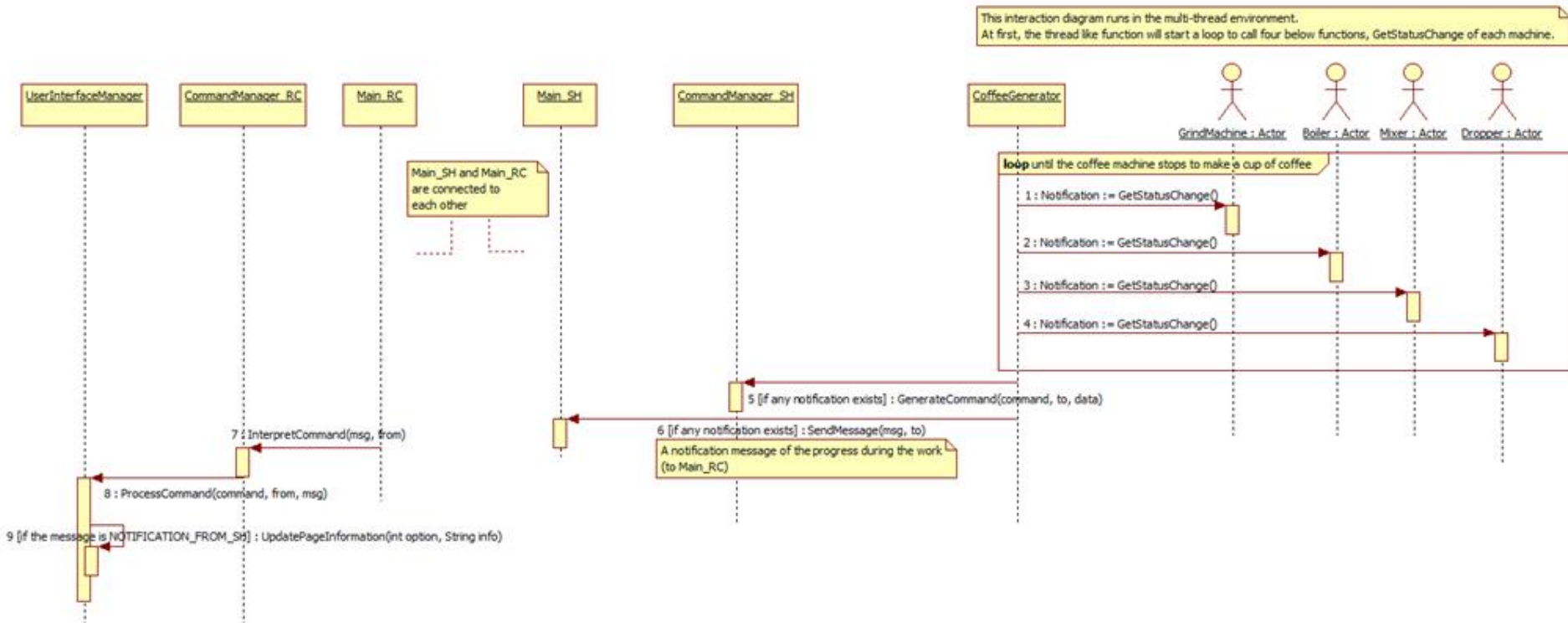

2244. Define Interaction Diagram

11. Cancel ordered coffee

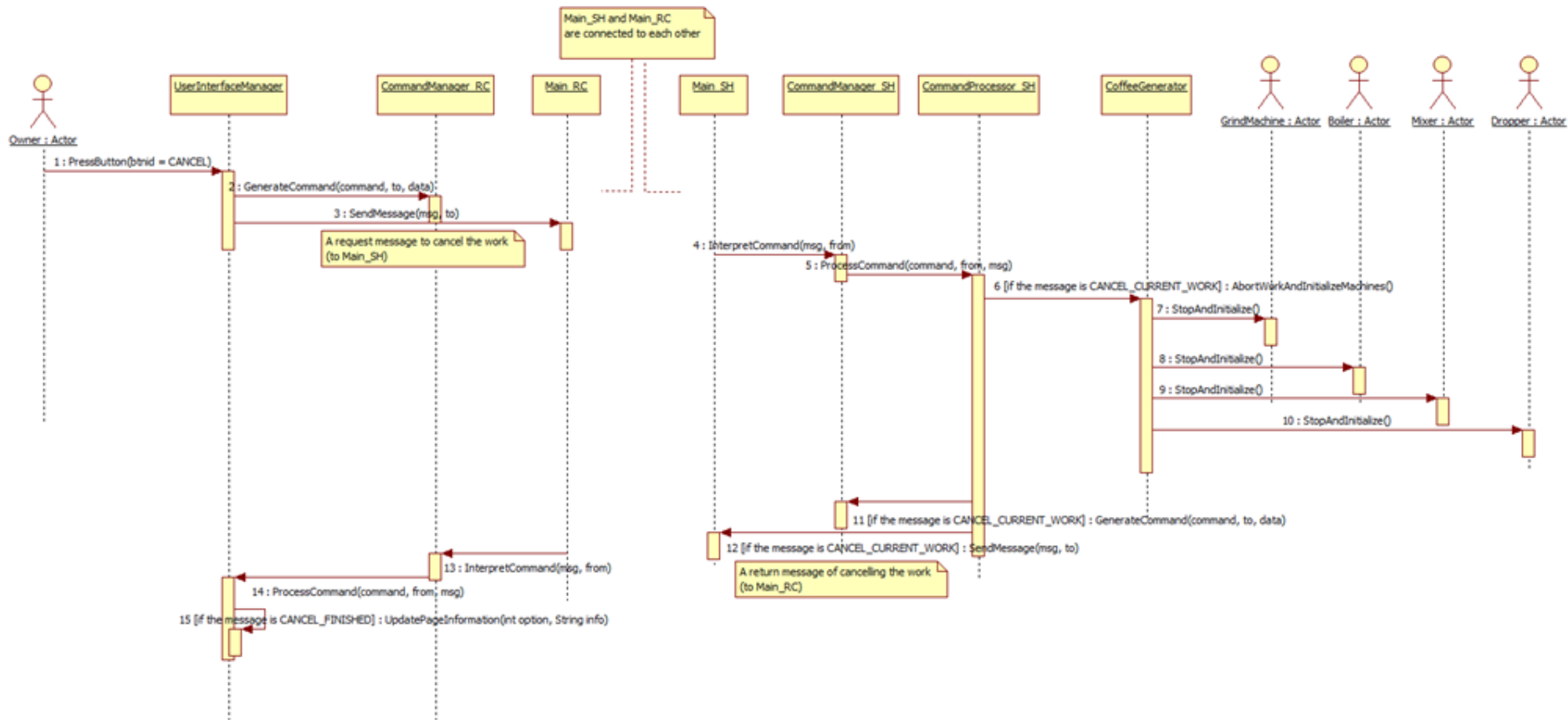

2244. Define Interaction Diagram

12. Select music

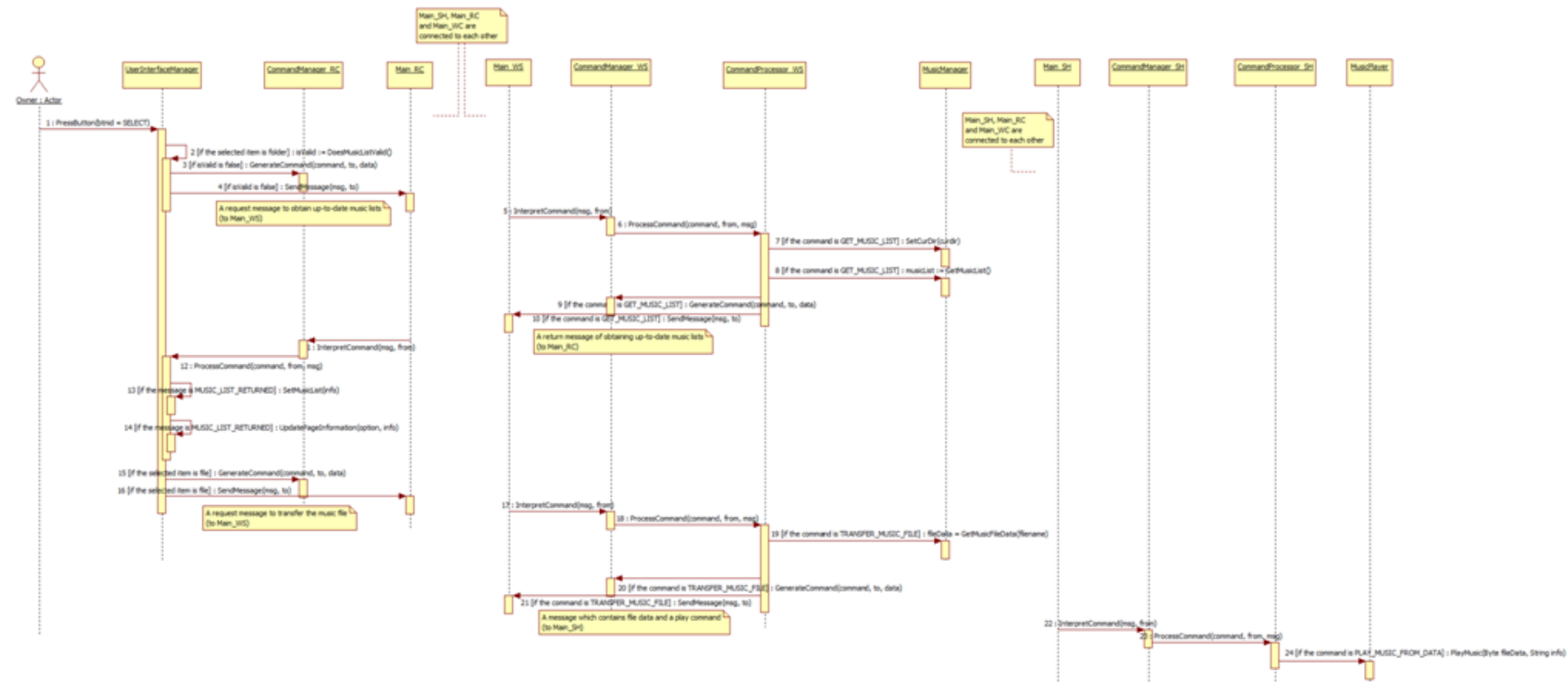

2244. Define Interaction Diagram

13. Stop music

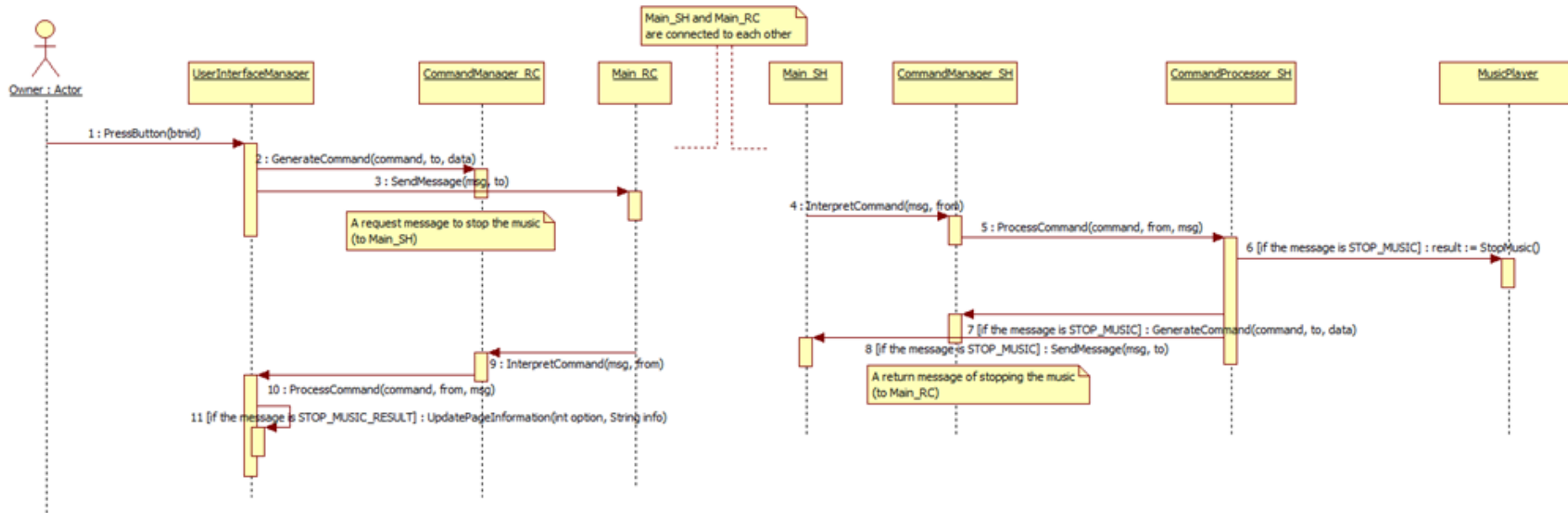

2244. Define Interaction Diagram

14. Change volume

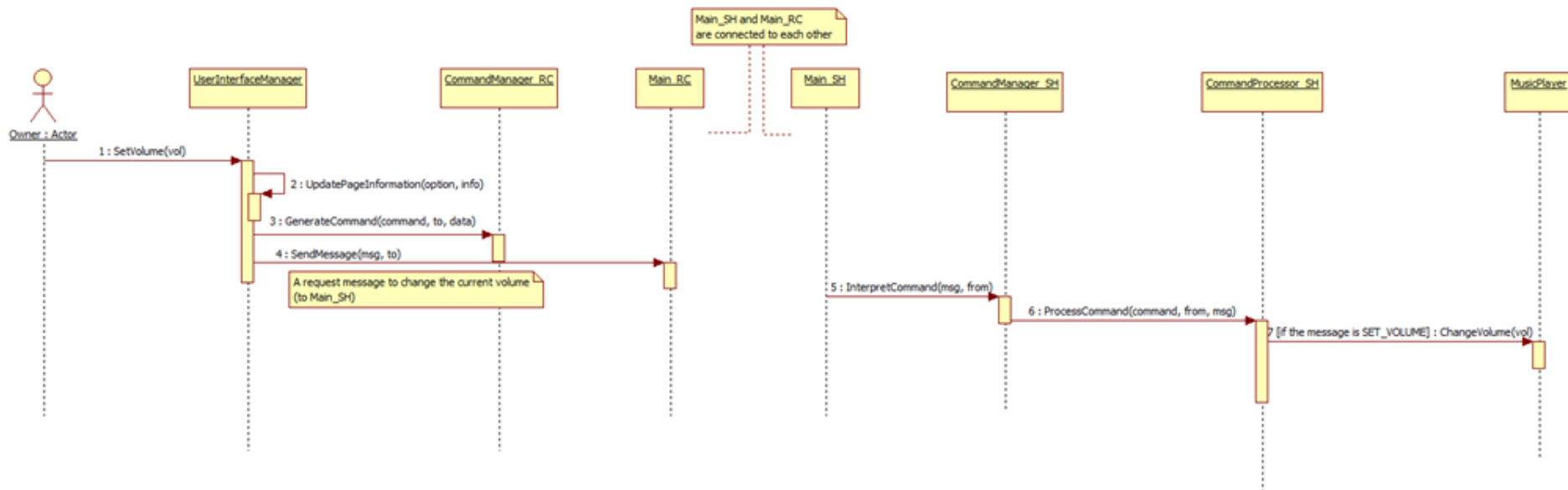

2245. Define Class Diagrams

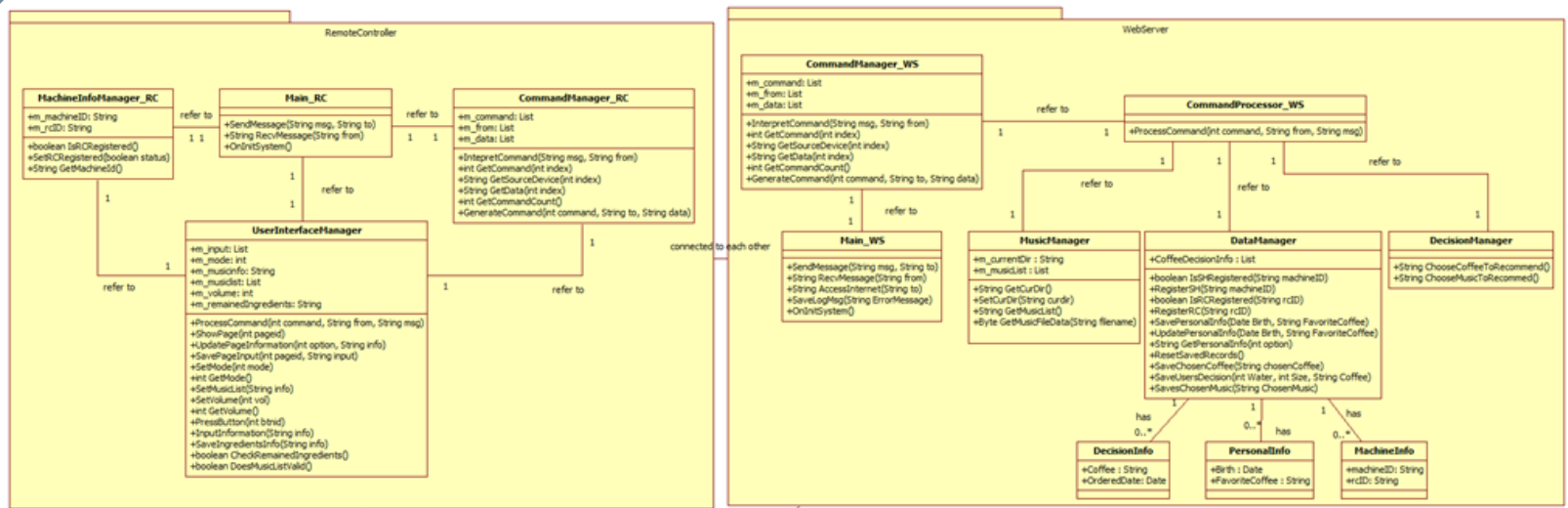

connected to each other

connected to each other

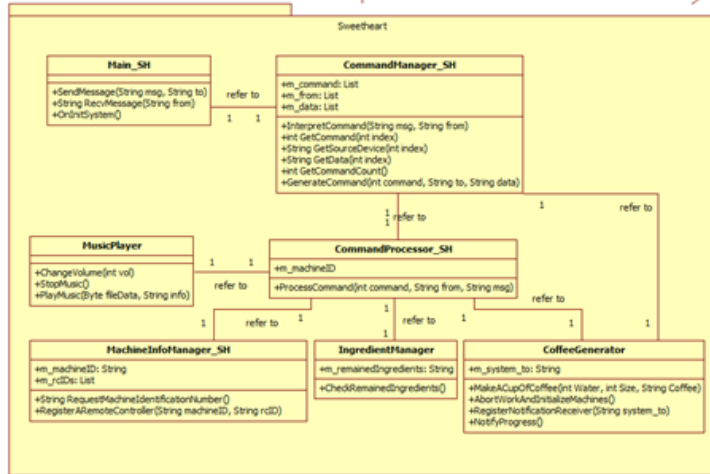

2245. Define Class Diagrams

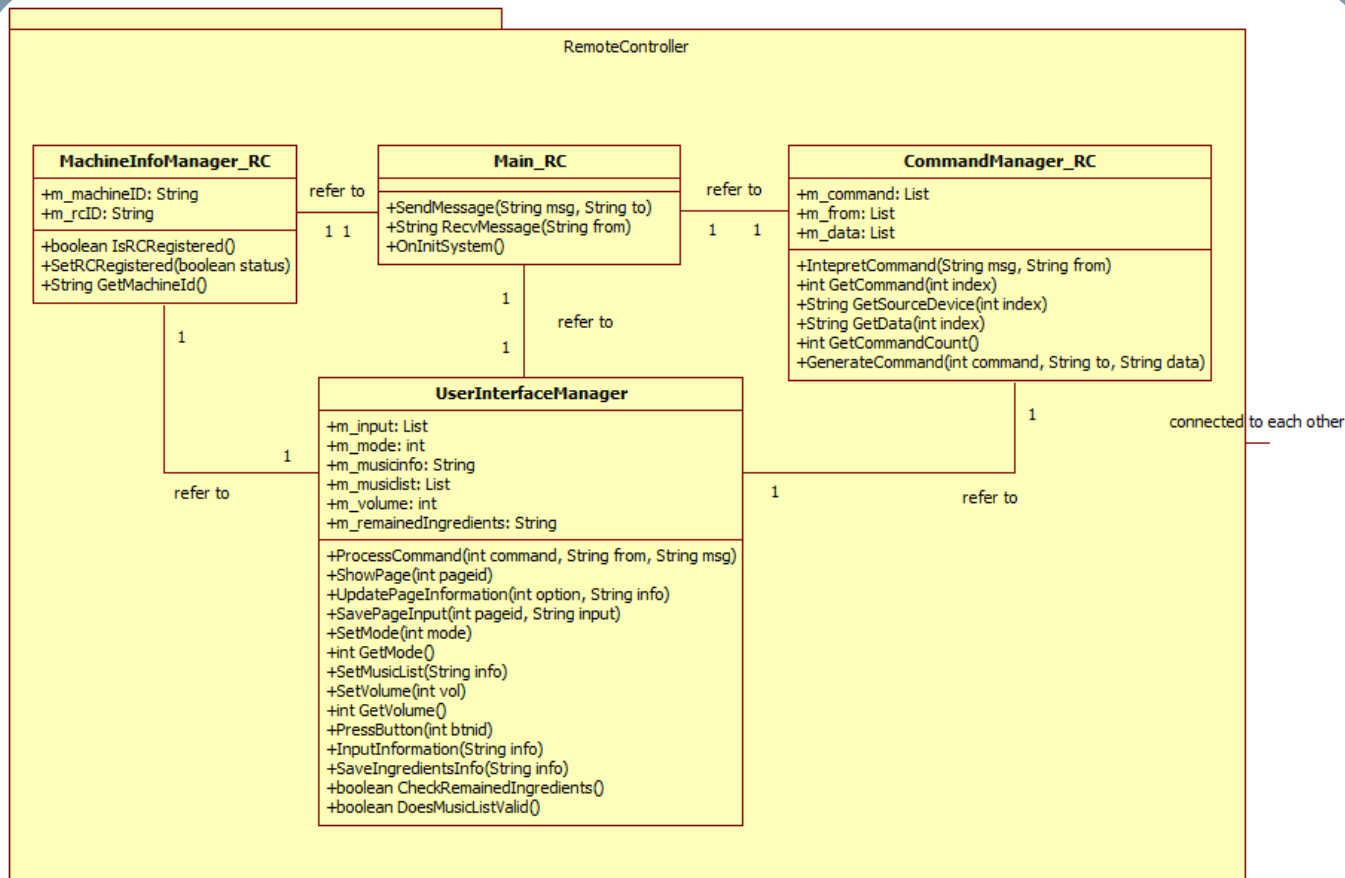

connected to each other

connected to each other

2245. Define Class Diagrams

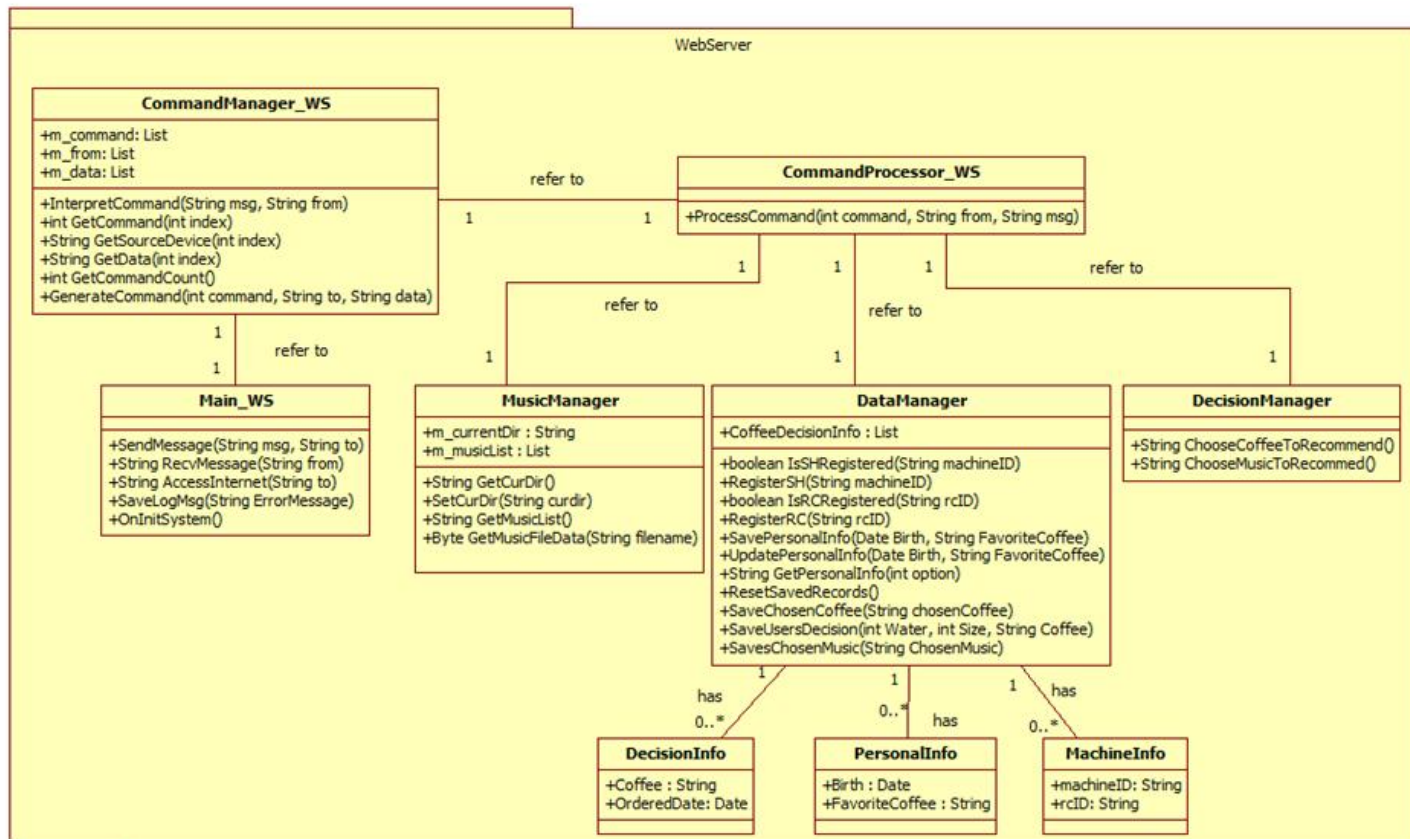

connected to each other

2245. Define Class Diagrams

connected to each other

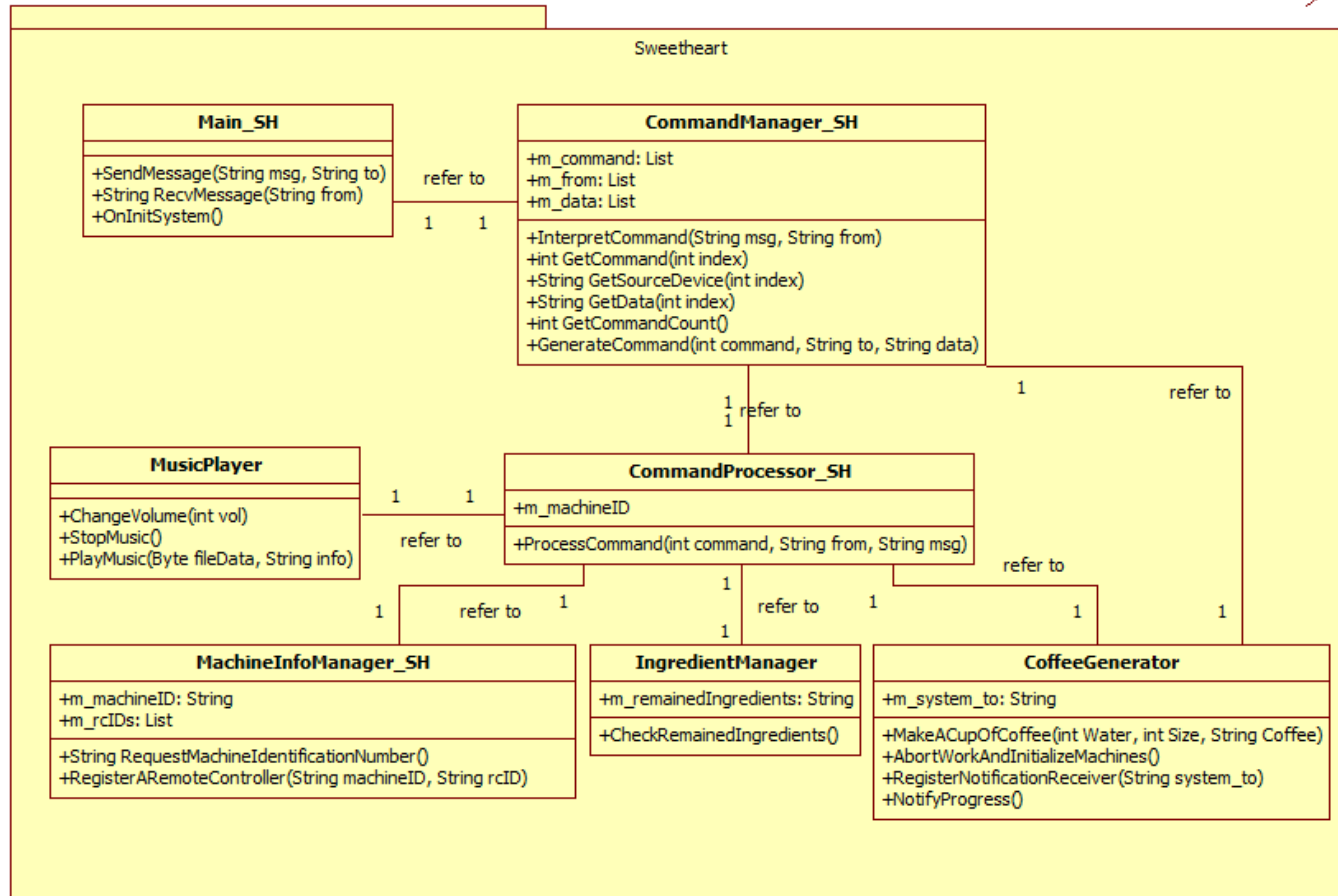

2246. Define Database Schema

PersonallInfo

Name	Type
Birth	Date
FavoriteCoffee	String

Personal Information.

These records stand for saving users' preferences and birth information to recommend a cup of coffee and a music which will be played during the coffee machine is working.

DecisionInfo

Name	Type
Coffee	String
OrderedDate	Date

Decisions.

These records stand for saving users' decisions such as a ordered coffee to recommend more favorable coffee adaptively.

MachineInfo

Name	Type
machineID	String
rcID	String

Machine Information.

These records stand for saving machines' and remote controller's information. The system matches and links the coffee machine and a remote controller by using the records to make a connection between the certain coffee machine and the specific remote controller